

Metal Package PMT with Gate Function

Photosensor Modules H11526 Series



The H11526 series is a photosensor module that allows gate operation. The combination of built-in metal package PMT and gate circuit makes this module compact yet still provides excellent characteristics: 100 ns minimum gate width, 10 kHz repetition rate. This module also contains a high-voltage power supply so that PMT gain can be varied by simply adjusting the control voltage. The internal protection monitor issues an error signal if high-intensity light enters the module.

Product Variations

Parameter	Spectral Response	Features
H11526-110-NN / H11526-110-NF	230 nm to 700 nm	Super bialkali photocathode, High sensitivity in visible range
H11526-01-NN / H11526-01-NF	230 nm to 870 nm	For UV to near IR range
H11526-20-NN / H11526-20-NF	230 nm to 920 nm	Extended red multialkali photocathode with enhanced sensitivity

Gate Mode NN: Normally ON
NF: Normally OFF

This product can't be used at vacuum environment or reduced pressure environment.

Specifications

(at +25 °C)

Parameter		H11526 Series		Unit
Suffix		-110-NN / -01-NN / -20-NN	-110-NF / -01-NF / -20-NF	—
Gate Mode	Mode	Normally ON		—
	Gate Width (FWHM)	100 ns to DC		—
	Rise Time	8	70	ns
	Fall Time	70	8	ns
	Repetition Rate	Max.	10	kHz
	Switching Ratio		10 ⁶	—
	Switching Noise *1	Max.	30	mV
	Delay Time	Max.	80	ns
Gate Jitter	Max.	1	ns	
Gate Signal Input	Level	C-MOS (High level: +3.5 V to +5 V)		—
	Input Impedance	10		kΩ
	Pulse Width	20 ns to DC		—

*1: Load resistance = 50 Ω (peak to peak)

Photosensor Module with Gate Function

Parameter		H11526 Series			Unit	
Suffix		-110-NN / -110-NF	-01-NN / -01-NF	-20-NN / -20-NF	—	
Input Voltage		+14.5 to +15.5			V	
Max. Input Voltage		+16			V	
Max. Input Current		60			mA	
Max. Surge Current		300			mA	
Max. Output Signal Current		100			μA	
Pulse Linearity (±5 % Deviation) *2		30			mA	
Max. Control Voltage		+0.9 (Input Impedance 10 kΩ)			V	
Recommended Control Voltage Adjustment Range		+0.4 to +0.9 (Input Impedance 10 kΩ)			V	
Effective Area		φ8			mm	
Peak Sensitivity Wavelength		400	400	630	nm	
Cathode	Luminous Sensitivity	Min.	80	100	350	μA/lm
		Typ.	105	200	500	
	Blue Sensitivity Index (CS 5-58)	Typ.	13.5	—	—	—
	Red / White Ratio	Typ.	—	0.2	0.45	—
Radiant Sensitivity *3		Typ.	110	77	78	mA/W
Anode	Luminous Sensitivity *2	Min.	80	100	350	A/lm
		Typ.	210	400	1000	
	Radiant Sensitivity *2 *3	Typ.	2.2 × 10 ⁵	1.5 × 10 ⁵	1.5 × 10 ⁵	A/W
	Dark Current *2 *4	Typ.	1	1	10	nA
Max.		10	10	100		
Time Response *2	Rise Time	Typ.	0.57			ns
	Transit Time	Typ.	2.7			ns
	T.T.S.	Typ.	0.2			ns
Ripple Noise *2 *5 (peak to peak)		Max.	5			mV
Settling Time *6		Max.	2			s
Operating Ambient Temperature *7		+5 to +45			°C	
Storage Temperature *7		-20 to +50			°C	
Weight		105			g	

*2: Control voltage = +0.8 V

*3: Measured at the peak sensitivity wavelength

*4: After 30 minutes storage in darkness.

*5: Cable RG-174/U, Cable length 450 mm, Load resistance = 1 MΩ, Load capacitance = 22 pF

*6: The time required for the output to reach a stable level following a change in the control voltage from +0.8 V to +0.4 V.

*7: No condensation

Characteristics (Cathode radiant sensitivity, Gain)

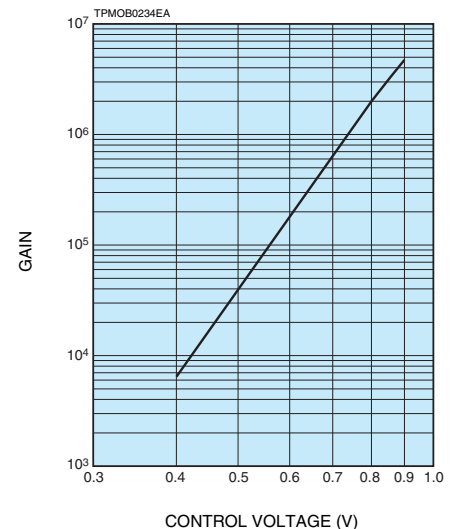
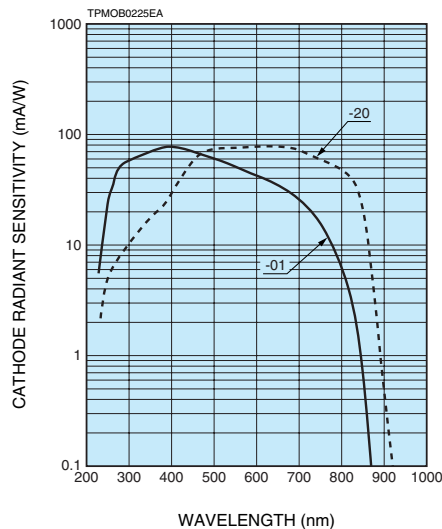
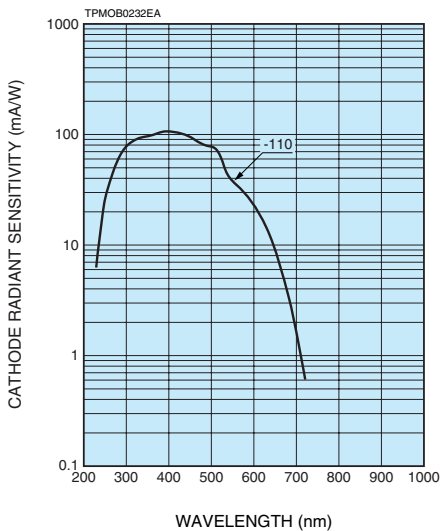

Metal Package PMT with Gate Function

Gate Timing Chart

Normally ON Type

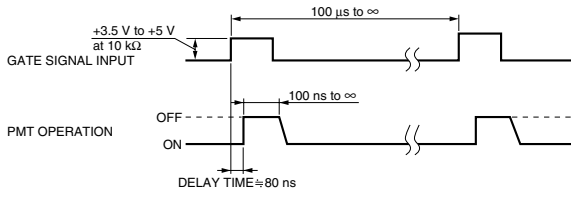

Normally OFF Type

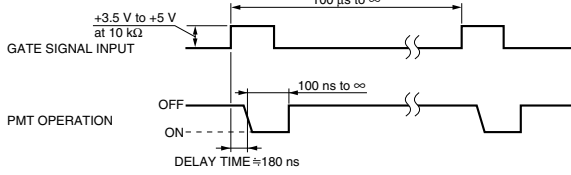

TPMOC0200EA

Output Examples

Normally ON Type

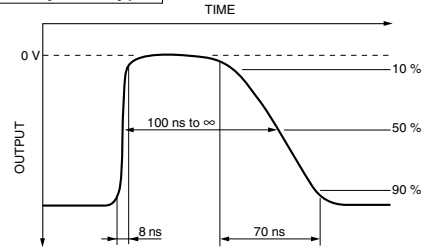

TPMOC0205EA

Normally OFF Type

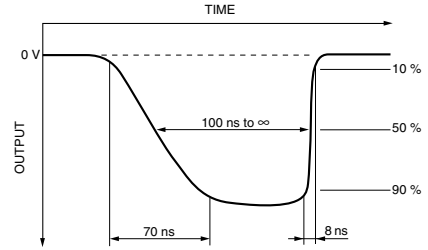

TPMOC0206EA

Gate Time Characteristics

Normally ON Type

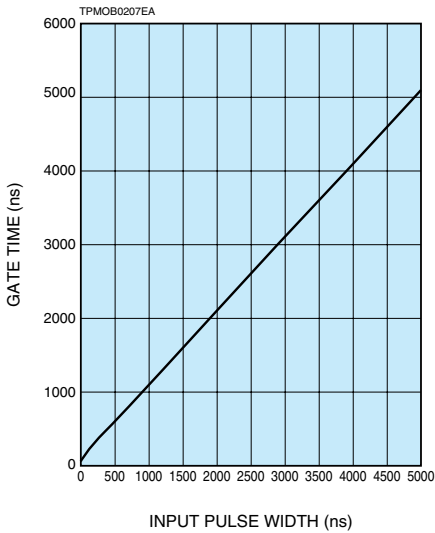

Normally ON Type closeup

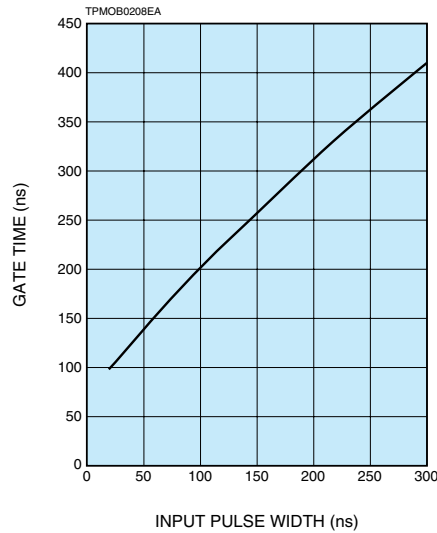

Normally OFF Type

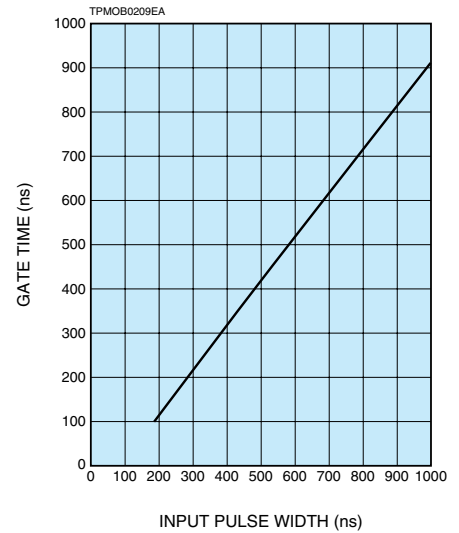

Block Diagram

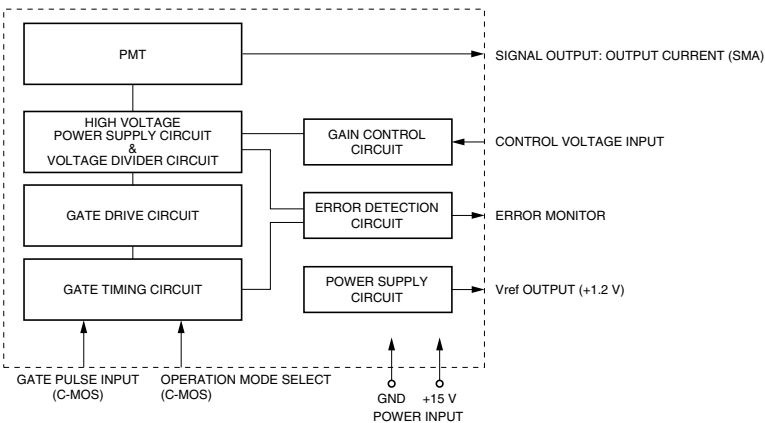

TPMOC0201EB

Photosensor Module with Gate Function H11526 Series

Sensitivity Adjustment Method

Voltage Programming

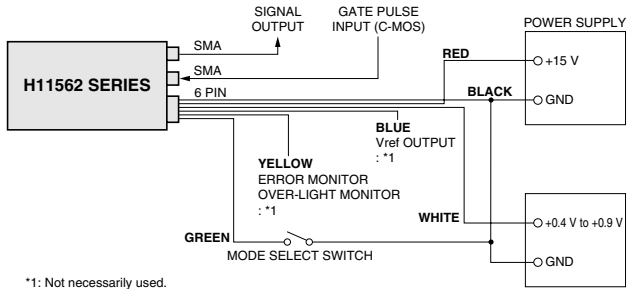

TPMOC0236EA

Resistance Programming

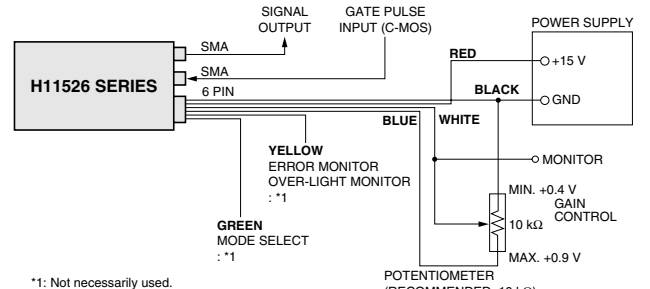

TPMOC0237EA

Dimensional Outlines (Unit: mm)

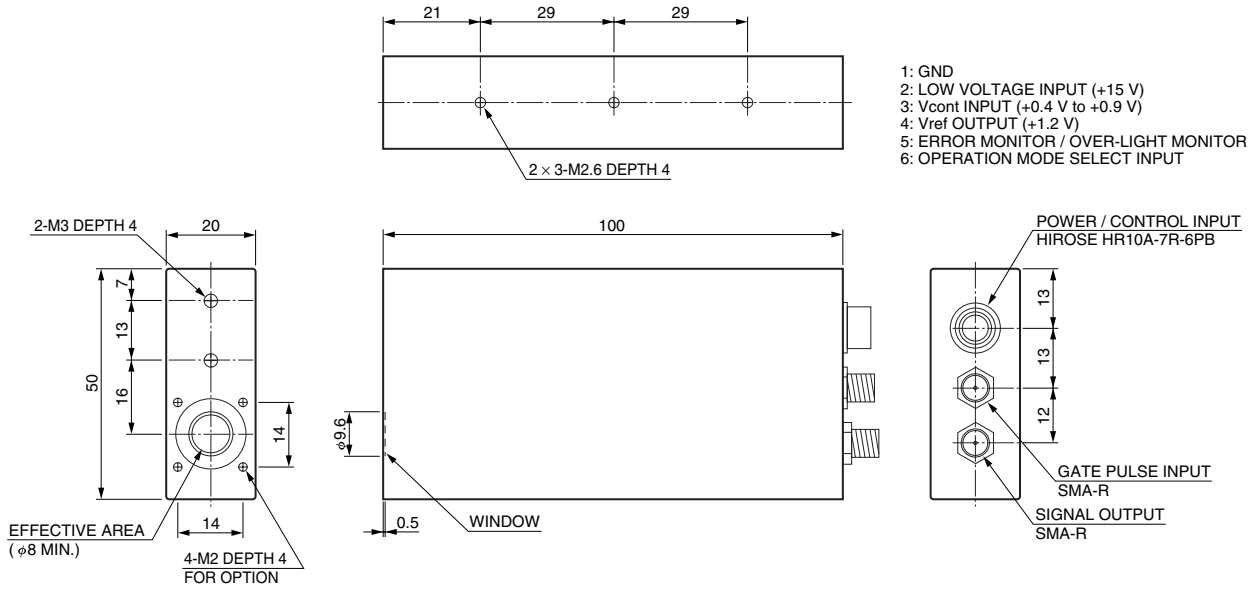

Power cable with connector (HIROSE HR10A-7P-6S) is supplied with H11526 series

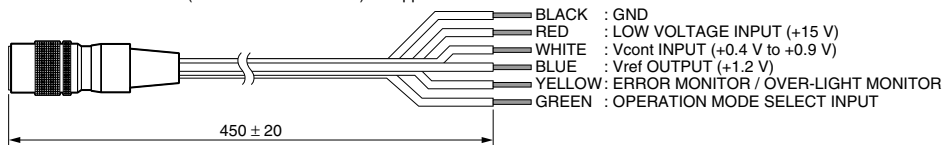

TPMOA0071EA